











































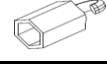



Komponente za:

Žaluzije 19x27				
Slika	Šifra	Opis	ME	min količina
	160-0000-000	Perma reduktor	kos/pc	100
	155-0000-000	Perma vrvna zapora	kos/pc	100
	059-9000-000	Reduktor M40	kos/pc	100
	059-9100-000	Reduktor M40 s kardanom	kos/pc	100
	080-0000-000	Vrvna zapora M40	kos/pc	100
	039-9000-000	Reduktor M39	kos/pc	100
	039-9100-000	Reduktor M39 s kardanom	kos/pc	100
	015-0000-000	Vrvna zapora AK-ROL	kos/pc	100
	015-9100-000	Vrvna zapora M15	kos/pc	100
	H06M	Rolica osnega podstavka	kos/pc	1000
	H05R	Osni podstavek 19 x 27	kos/pc	1000
	016-0000-000	Stranski čep zg. Nosilca, bela, rjav, transp.	kos/pc	500
	095-0000-000	Stranski čep zg, nosilca notr. 19x27 - Transp.	kos/pc	100
	T0006	Stenska konzolica 19 x 27	kos/pc	100
	T0007	Stropna konzolica 19x27	kos/pc	100
	020-0010-000	Pritrdilna Lkonzola za medstekelne žal.	kos/pc	1000
	082-0010-000	Inštalacijska U konzola 19x27	kos/pc	100
	027-0000-300	Osovina Zn D, L-3m	m/m	300
	045-0000-000	Gumica za os	kos/pc	1000
	16-AL-000	Al. Lamela 16mm, TURNILS	m/m	2.012
	25-AL-018	Al. Lamela 25mm,0,18mm, TURNILS	m/m	2.012

	25-AL-021	Al. Lamela 25mm,0,21mm, TURNILS	m/m	1524
	50-AL-021	Al. Lamela 50mm,0,21mm, TURNILS	m/m	610
	049-9000-000	Plastična sponka lamele 25mm	kos/pc	500
	8025011000	Lestvica 21,5x28 bela, Turnils	m/m	500
	5025011001	Lestvica 21,5x28 barvasta, Turnils	m/m	500
	012-0000-000	Obesek vrvice Ø 2mm - bel, čoko,transp.	kos/pc	1000
	8000141000	Vrvica 1,4mm, bela, Turnils	m/m	1000
	8000141001	Vrvica 1,4mm, barvasta, Turnils	m/m	1000
	011-9100-000	Obesek vrvice-stekleni	kos/pc	100
	006-90..⁵-080	Vzmetna požirna cev, bela, čoko	kos/pc	500
	048-0019-080	Vzmetna požirna cev z vrvno zaporo	kos/pc	100
	047-00..⁵-000	Navijalnio gumb, bel, čoko	kos/pc	1000
	040-0100-300	Steklena palica L-3m	m/m	300
	040-0200-000	Kavelj steklene palice	kos/pc	100
	040-0300-000	Ročaj steklene palice	kos/pc	100
	026-90..⁵-150	Pregibno vreteno, L-150mm	kos/pc	500
	026-90..⁵-220	Pregibno vreteno, L-220mm	kos/pc	500
	028-90..⁵-017	Pregibna komandna palica, K-65, L-170mm	kos/pc	100
	028-90..⁵-025	Pregibna komandna palica, K-65, L-250mm	kos/pc	100
	028-90..⁵-030	Pregibna komandna palica, K-65, L-300mm	kos/pc	100
	028-90..⁵-050	Pregibna komandna palica, K-65, L-500mm	kos/pc	100
	028-90..⁵-075	Pregibna komandna palica, K-65, L-750mm	kos/pc	100
	028-90..⁵-100	Pregibna komandna palica, K-65, L-1000mm	kos/pc	100

	028-90..⁵-130	Pregibna komandna palica, K-65, L-1300mm	kos/pc	100
	031-00..⁵-050	Podaljšek komandne palice L-500mm	kos/pc	100
	031-00..⁵-100	Podaljšek komandne palice L-1000mm	kos/pc	100
	008-90..⁵-000	Držalo komandne palice	kos/pc	1000
	014-9000-000	Str. Čep sp. Profila, bel, čoko, transp.	kos/pc	1000
	6422420000	Str. Čep sp. Profila veliki C, transparent	kos/pc	500
	093-01..²-000	Str. Čep sp. Profila mali C, transparent	kos/pc	500
	093-0200-000	Ušesek za str. Čep C	kos/pc	500
	019-0000-000	Sidrni gumb Ø 5,6mm - bel, čoko, Transp.	kos/pc	1000
	003-0000-000	Sidrni gumb Ø 6,6mm - bel, čoko, Transp.	kos/pc	1000
	064-0011-000	Pušica za laks Ø 4mm	kos/pc	100
	091-0000-000	Laks vodilo Ø 1,0mm	m/m	2,05kg = 4000m
	063-00..⁵-000	Spodnja kovinska L konzola, bela, čoko	kos/pc	100
	063-0110-000	Spodnja kovinska L konzola, cink	kos/pc	100
	3135	Kocka za laks, bela, čoko	kos/pc	100
	10-OBL-ZG.	Zg. nosilec 19x27, L-4m OBLAK, beli	m/m	200
	11-OBL-ZG.	Zg. nosilec 19x27 - L-4m OBLAK, barvni	m/m	200
	6212320000	Zg. nosilec 19x27 - Turnils	m/m	120
	A17ZG.	Zg. nosilec 19x27 -Isotra, L-4m-Beli	m/m	200
	A18ZG.	Zg. nosilec 19x27 -Isotra, L-4m-Barvni	m/m	200
	11-OBL-SP	Sp. Profil za žal. OBLAK, L-4m, barvast	m/m	125
	10-OBL-SP	Sp. Profil za žal. OBLAK, L-4m, bel	m/m	125
	A17SP.	Sp. Profil za žal. Isotra, L-4m, bel	m/m	125

	A18SP.	Sp. Profil za žal. Isotra, L-4m,barvni	m/m	150
	6252320000	Sp. Profil za žal. Veliki C, 25x10 standardni, Turnils	m/m	125

Sestavni deli za žaluzijo 19x27

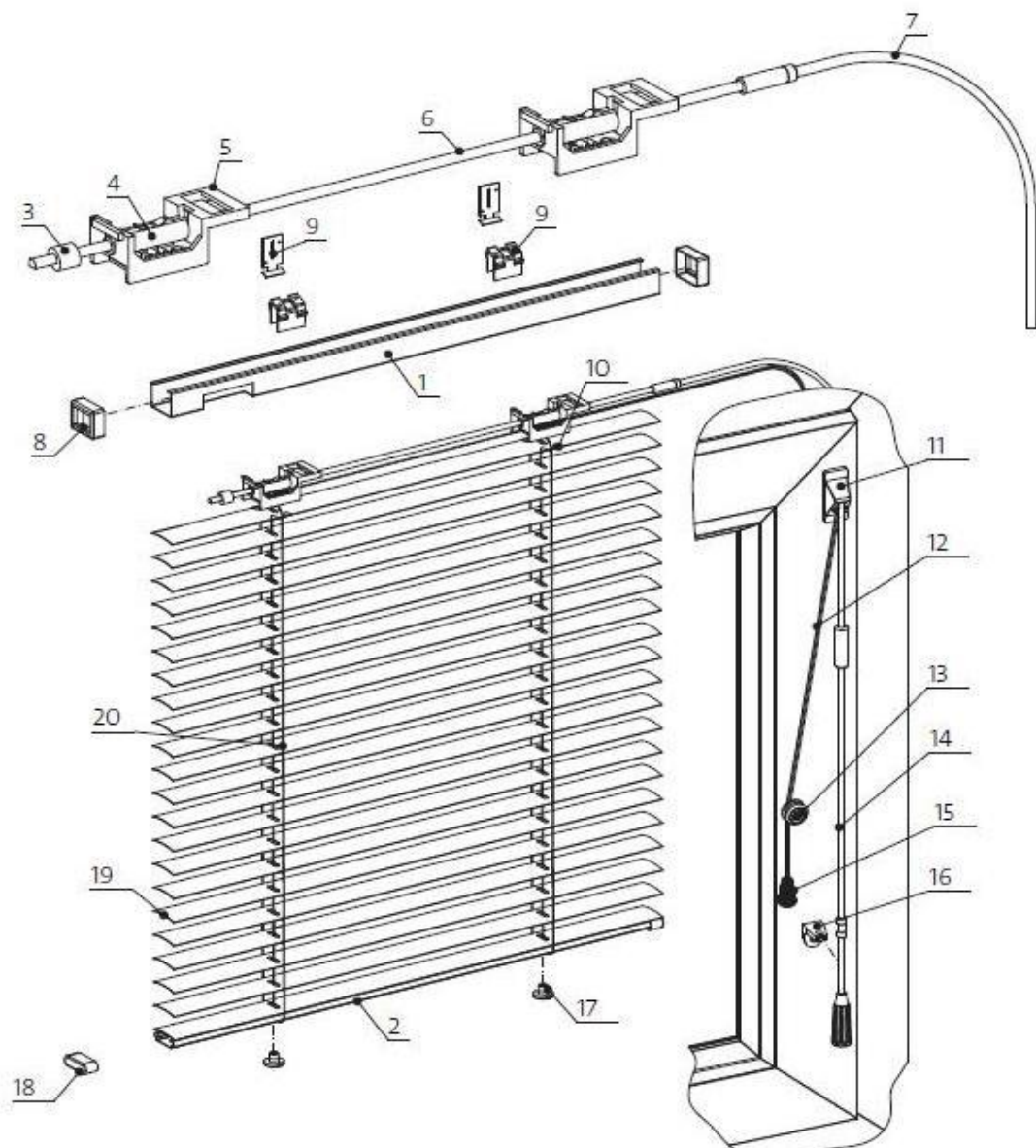

1. Zgornji profil
2. Spodnji profil
3. Gumica za os
4. Rolica osn. podstavka
5. Osn. podstavek
6. Osovina
7. Pregibno vreteno
8. Str. čep zg. profila
9. Konzola
10. Sponka prve lamele

11. Vzmetna požiralna cev
12. Vrvica
13. Navijalni gumb
14. Komandna palica
15. Obesek vrvice
16. Držalo komandne palice
17. Sidrni gumb
18. Str. čep sp. profila
19. Lamela
20. Lestvica